

# *Movopart M50*

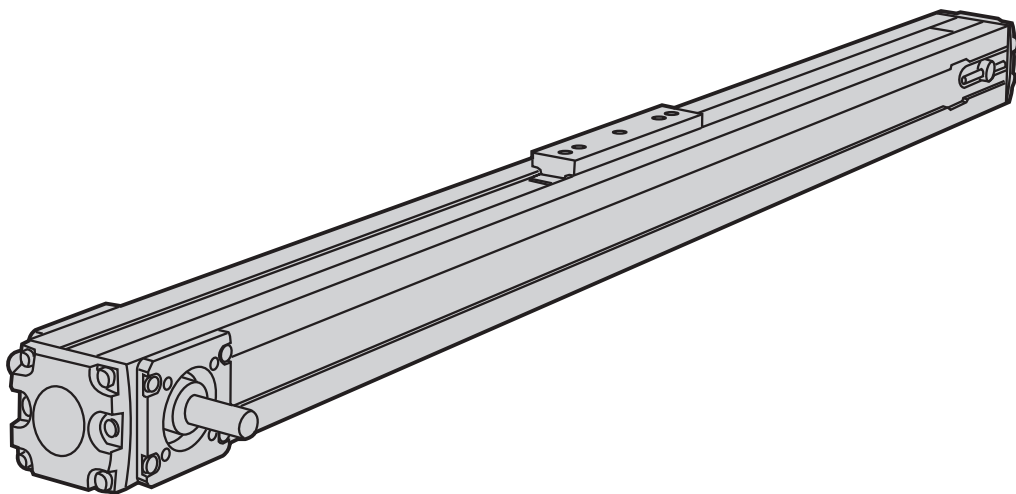

***Installation and Service Manual***  
***Edition: 2***  
***DW110242gb-0446***

# 1. Installation

## 1.1 Mounting of the unit

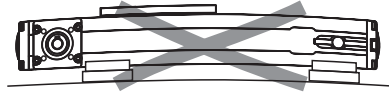
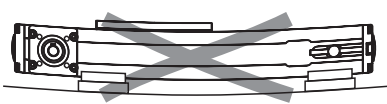
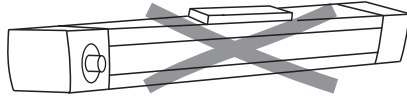

## 1.2 Maximum distance between mounting points

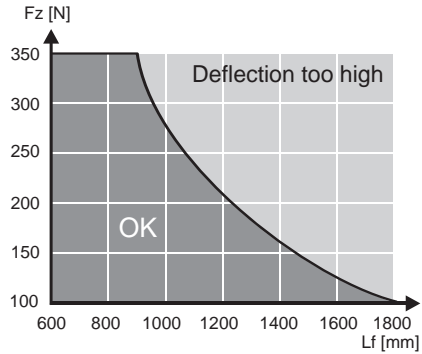
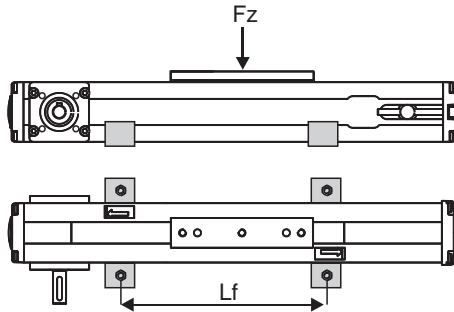

## 1.3 Maximum stroke

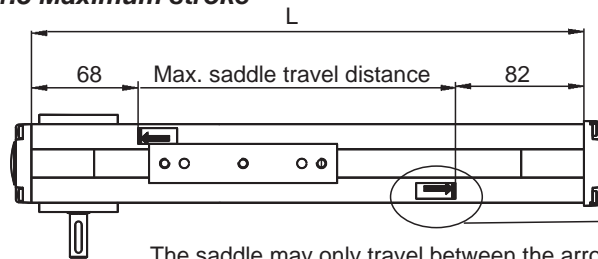

Max. stroke =  $L - 270$

The saddle may only travel between the arrowmarks!

## 1.4 Saddle mounting holes

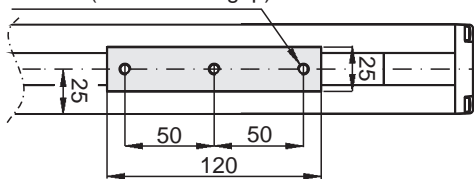

## 1.5 Motor support

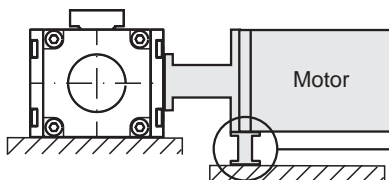

Always support the motor!

# 1. Installation

## 1.6 Motor flange

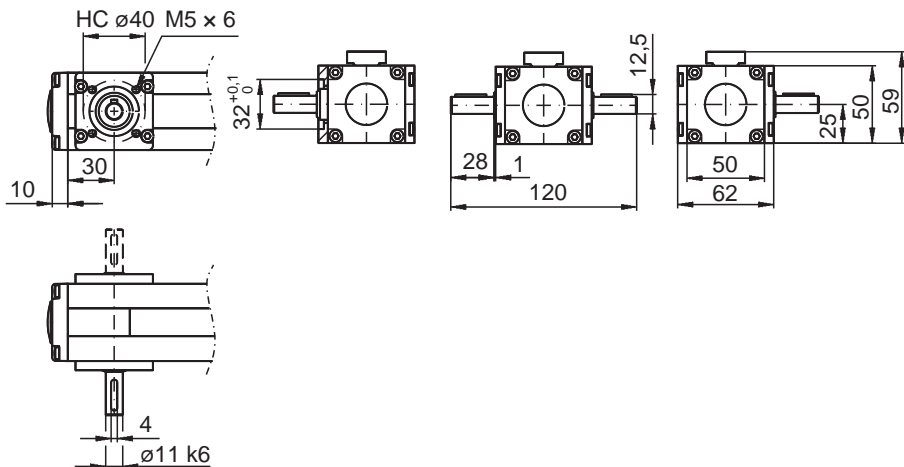

## 1.7 Location of magnet for magnet sensors

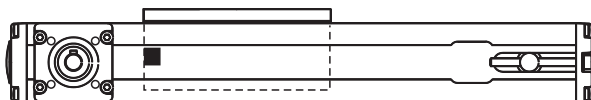

Magnets are fitted on both sides of the saddle. Remember to fit any sensors before fitting the mounting clamps to the unit.

## 1.8 End of stroke limit switches



Limit switches should be used at both ends of stroke to avoid the saddle running in to the belt wheels. The distance between the switches and the ends of the unit depends on the deceleration rate of the drive system.

## 2. Service and maintenance

### 2.1 Lubrication

No lubrication is needed as the unit is lubricated for life.

### 2.2 Adjustment of the belt tension

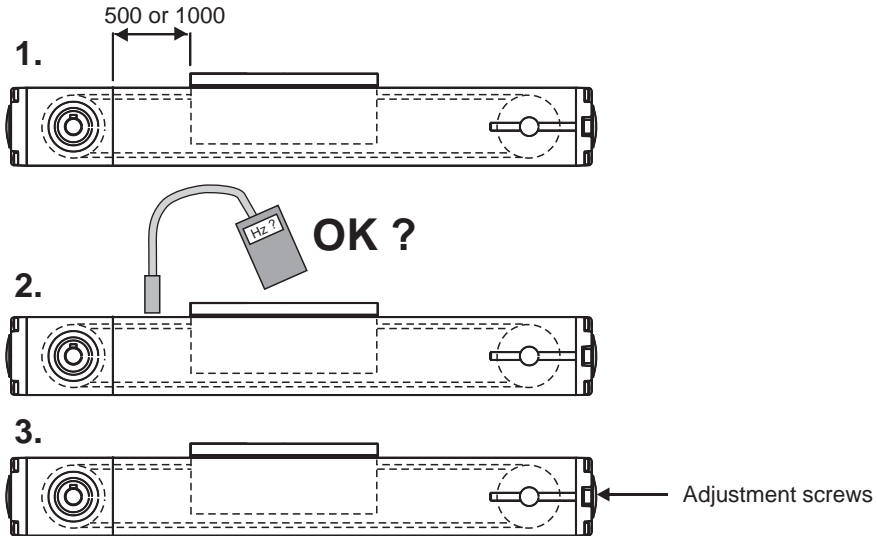

The belt must be set to the correct tension after a belt replacement.

1. Place the saddle at 500 or 1000 mm from the drive station.
2. Measure the belt frequency with a frequency meter according to the instructions for the frequency meter in question. The correct frequency is 68,6 Hz for 500 mm and 34,3 Hz for 1000 mm.
3. Adjust the adjustment screws if the frequency is not correct. Check the belt position when the correct tension is set.

### 2.3 Adjustment of the belt position

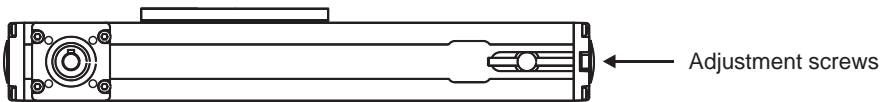

The belt should normally run in the centre or from side to side of the belt wheels. But if the belt runs against one side only the belt position needs to be adjusted to avoid increased belt wear. The belt tension should be correctly set before any belt position adjustment.

1. Remove the plastic cover in the cover plate in the tension end and check the belt position while the unit is running.
2. If adjustment is needed, tighten the tension screw a little bit on the side that the belt runs against.
3. Check the belt position again.
4. If the belt still runs on one side only, repeat from point 2.

## 2. Service and maintenance

### 2.4 Replacement of the belt

1.

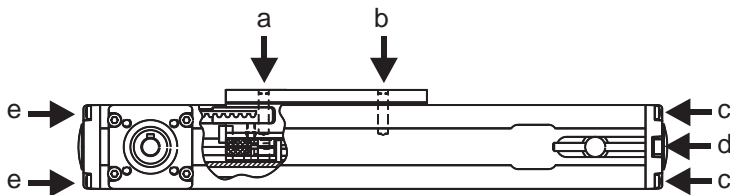

First remove the belt holder pins in the saddle (a and b). The pins are removed by screwing a M4 screw into them and then pull them up. Then remove the tension station screws (c) and loosen the belt tension adjustment screws (d) as much as possible. At last remove the drive end cover plate screws (e) so that it can be removed.

2.

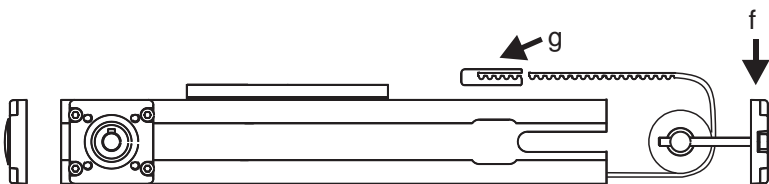

Pull out the tension station (f) and the belt so that the belt holder (g) can be removed from the old belt.

3.

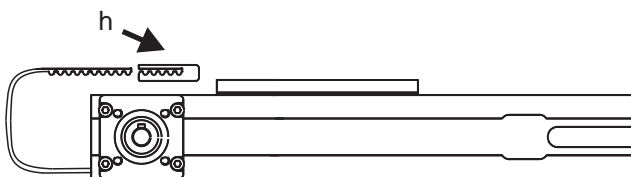

Pull out the old belt from the drive end and remove the belt holder (h).

4.

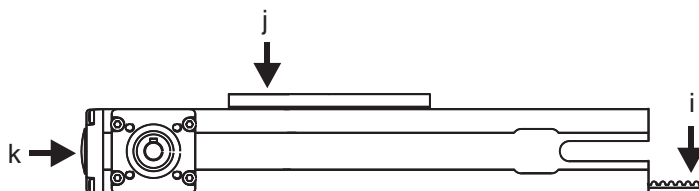

Insert the new belt (i) and put it around the drive wheel. Place the belt holder on the belt and then insert the holder in to the saddle. Fix the belt to the saddle using the belt holder pin (j). Put back the drive station cover plate (k).

## 2. Service and maintenance

### 2.4 Replacement of the belt

5.

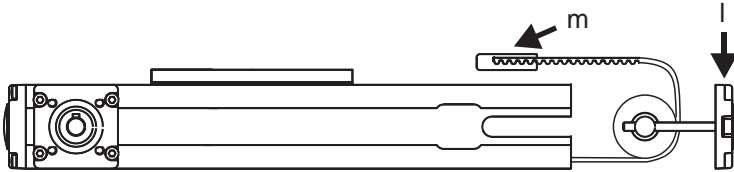

Put the new belt around the tension station wheel (l) and then put the belt holder on the belt end (m).

6.

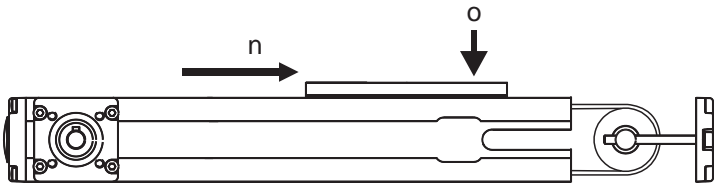

Push the saddle to the other side of the unit (n) and fix the belt holder to the saddle again using the belt holder pin (o).

7.



Attach the tension station to the profile again (p) and set the correct belt tension by adjusting the belt tension adjustment screws (r). See instruction 2.2. Finally check the belt position, see instruction 2.3.

### 3. Technical data

#### 3.1 Technical data table

	M50
Max. speed [m/s]	5
Max. input speed [rpm]	2300
Temperature range [°C]	-20 – +70
Weight (L in meters) [kg]	$0,71 + L \times 2,5$
Saddle weight [kg]	0,33
Max. load Fx [N]	400
Max. load Fy [N]	350
Max. load Fz [N]	350
Move [mm/rev.]	130
Repeatability [ $\pm$ mm]	0,2
Resolution [mm]	1,5

#### 3.2 Definition of forces

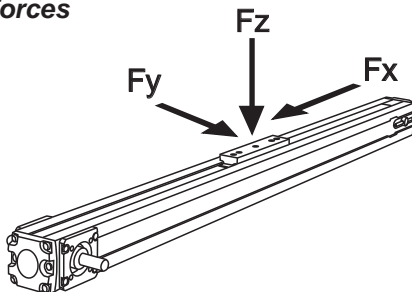

## Sales and Service

Danaher Motion products are available worldwide through an extensive authorised Distributor network. These distributors offer literature and technical assistance.

Danaher Motion sales engineers are conveniently located to provide prompt attention to customers' needs. Call the nearest office listed for ordering.

### France

Danaher Motion  
C.P. 80018  
12, Rue Antoine Becquerel - Z.I. Sud  
Bâtiment Paul Tiger 2  
F-72026 Le Mans Cedex 2, France  
Tel. +33 (02) 43 50 03 30  
Fax. +33 (02) 43 50 03 39  
E-mail: sales.france@danahermotion.com

### Germany

Danaher Linear GmbH  
Postfach 1153  
D-72645 Wolfschlugen, Germany  
Tel. +49 (0) 180 5 24 67 90  
Fax. +49 (0) 180 5 24 40 85  
E-mail: helpdesk@tollo.com

### Italy

Danaher Motion srl  
Via Brughetti  
200 30 Bovisio Masciago, Italy  
Tel. +39 (0) 362 594 260  
Fax. +39 (0) 362 594 263  
E-mail: info@danahermotion.it

### Spain

Danaher Motion  
Tollo Linear  
Badal, 2931 7th, 1st  
08014 Barcelona, Spain  
Tel./Fax. +34 (0) 9329 80278  
E-mail: helpdesk@tollo.com

### Scandinavia

Danaher Motion  
Tollo Linear AB  
Box 9053  
SE-291 09 Kristianstad, Sweden  
Tel. +46 (0)44 24 67 00  
Fax. +46 (0)44 24 40 85  
E-mail: helpdesk@tollo.com

### United Kingdom

Danaher Motion  
Fishleigh Road  
Roundswell Business Park  
Barnstaple, Devon  
EX31 3UD, UK  
Tel. +44 (0) 1271 334500  
Fax +44 (0) 1271 334502  
E-mail: LMSEurope@danahermotion.com

DANAHER MOTION is a registered trademark of Danaher Corporation. Danaher Motion makes every attempt to ensure accuracy and reliability of the specifications in this publication. Specifications are subject to change without notice. Danaher Motion provides this information "AS IS" and disclaims all warranties, express or implied, including, but not limited to, implied warranties of merchantability and fitness for a particular purpose. It is the responsibility of the product user to determine the suitability of this product for a specific application.

©2004 Danaher - Printed in Sweden. All rights reserved.